

# Internal Combustion Engines

## Mechanical Engineering

Comprehensive Theory *with* Solved Examples

**Civil Services Examination**



**MADE EASY Publications Pvt. Ltd.**

Corporate Office: 44-A/4, Kalu Sarai (Near Hauz Khas Metro Station), New Delhi-110016

E-mail: infomep@madeeasy.in

Contact: 9021300500

Visit us at: [www.madeeasypublications.org](http://www.madeeasypublications.org)

**Internal Combustion Engines**

© Copyright, by MADE EASY Publications Pvt. Ltd.

All rights are reserved. No part of this publication may be reproduced, stored in or introduced into a retrieval system, or transmitted in any form or by any means (electronic, mechanical, photo-copying, recording or otherwise), without the prior written permission of the above mentioned publisher of this book.

First Edition : 2018

Second Edition : 2019

Reprint : 2020

Reprint : 2021

Reprint : 2022

Reprint : 2023

**Reprint : 2024**

# Contents

## Internal Combustion Engines

### Chapter 1

#### Basic and Air Standard Cycle ..... 1

1.1 Introduction .....	1
1.2 Classification of IC Engines .....	1
1.3 Components of Engines .....	3
1.4 Basic Terminology .....	4
1.5 Otto Cycle Engines : Petrol Engines.....	6
1.6 Diesel Engines .....	8
1.7 Constant Volume or Otto cycle .....	11
1.8 Constant Pressure or Diesel Cycle .....	13
1.9 Dual Combustion Cycle .....	15
1.11 Comparison of Engines working on Otto and Diesel Cycle.....	18
1.12 Performance Parameters of IC Engine .....	18
1.13 Assumptions of Ideal Air Standard Cycle.....	23
1.14 Comparison among Otto, Diesel and Dual cycles.....	23

### Chapter 2

#### Combustion.....30

2.1 SI Engines .....	30
2.2 Stages of Combustion .....	31
2.3 Rate of Pressure Rise .....	37
2.4 Rate of Pressure Rise .....	37
2.5 Knock in SI Engine.....	38
2.6 CI Engines .....	42
2.7 Spray Characteristics.....	43
2.8 Stages of Combustion .....	44
2.9 Physical Factors Affecting Delay Period .....	45
2.10 Rate of Pressure Rise .....	48
2.11 Knock and CI Engine .....	49
2.12 Combustion Chamber Design Principle .....	51

2.13 Comparison in Knocking Phenomenon of SI Engine and CI Engine.....	52
2.14 CI Engine Combustion Chamber.....	52

### Chapter 3

#### Fuels and Emissions.....56

3.1 Requirement for an IC Engine Fuel .....	56
3.2 The Constituents of Crude Petroleum and their Properties.....	56
3.3 Important Products of Refining Process of Crude Petroleum .....	56
3.4 Effect of Volatility on Petrol Engine Performance .....	57
3.5 Octane Number (ON) .....	57
3.6 Requirements of the fuel for SI Engine.....	58
3.7 Cetane Number.....	58
3.8 Properties of Fuel for CI Engines.....	59
3.9 Alternative Fuels for I.C. Engines .....	59
3.10 Basic Performance Parameters of IC Engine.....	60
3.11 Measurement of Engine Parameters.....	61
3.12 Variation of Exhaust Constituents with Engine Parameters.....	63
3.13 Emissions in SI and CI .....	65
3.14 Various Methods Used to Control Emissions .....	66

### Chapter 4

#### Engine Friction, Lubrication and Cooling .....72

4.1 Friction Power.....	72
4.2 Components of engine Friction.....	72
4.3 Total Friction Work.....	73
4.4 Friction Mean Effective Pressure.....	73

4.5 Mechanical Friction .....	74	4.15 Additives for Lubricants .....	87
4.6 Mechanical Friction in Major Engine Components.....	75	4.16 SAE Viscosity Number.....	88
4.7 Blowby Losses .....	77	4.17 Lubricating Systems .....	89
4.8 Effect of Engine Variables on Friction .....	77	4.18 Crankcase Ventilation .....	92
4.9 Side Thrust On the Piston.....	78	4.19 Engine Performance And Lubrication.....	93
4.10 Lubrication .....	80	4.20 Cooling System .....	93
4.11 Functions of a Lubricant.....	80	4.21 Type of Cooling system.....	94
4.12 Lubrication Principles.....	81	4.22 Water Cooling System .....	96
4.13 Bearing Lubrication.....	82	4.23 Advanced Cooling Concepts .....	98
4.14 Properties of Lubricants.....	85	4.24 Common Coolant.....	100



# Basics and Air Standard Cycles

## 1.1 INTRODUCTION

The internal combustion (I.C.) engine is a heat engine that converts the chemical energy of a fuel into mechanical energy, usually mechanical energy available on a rotating output shaft. Chemical energy of the fuel is first converted to thermal energy by means of combustion of fuel with air inside the engine. This thermal energy raises the temperature and pressure of the gases inside the engine, and the high pressure gas then expands against the mechanical mechanism of the engine. This expansion of gas is converted by the mechanical linkages of the engine to a rotating crankshaft, which is the output of the engine.

## 1.2 Classification of IC Engines

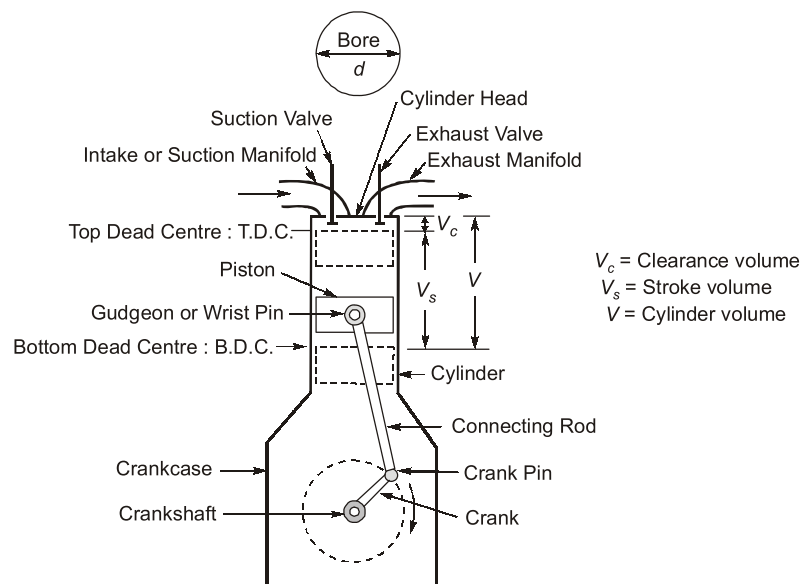

Fig. 1.1

The Internal combustion engines are usually of reciprocating type. The reciprocating internal combustion engines are classified on the basis of the thermodynamic cycle and mechanical method of operation, type of fuel used, type of ignition, type of cooling system and cylinder arrangement, etc. Detailed classification is given below:

### 1. According to number of strokes in the working cycle

- Four stroke engine
- Two stroke engine

2. According to fuel used
  - (a) Petrol or Gasoline engine
  - (b) Diesel engine
  - (c) Gas engine
  - (d) Multi-fuel engine
3. According to method of ignition
  - (a) Spark ignition
  - (b) Compression ignition
4. According to fuel-feeding system
  - (a) Carburetted engine
  - (b) Engine with fuel injection
5. According to charge feeding system
  - (a) Naturally aspirated engine
  - (b) Supercharged engine
6. According to cooling system
  - (a) Air-cooled engine
  - (b) Water-cooled engine
7. According to number of cylinders
  - (a) Single cylinder engine
  - (b) Multi-cylinder engine
8. According to speed of the engine
  - (a) Low-speed engine
  - (b) Medium-speed engine
  - (c) High-speed engine
9. According to arrangement of cylinders
  - (a) Horizontal engine
  - (b) Vertical engine
  - (c) V-engine

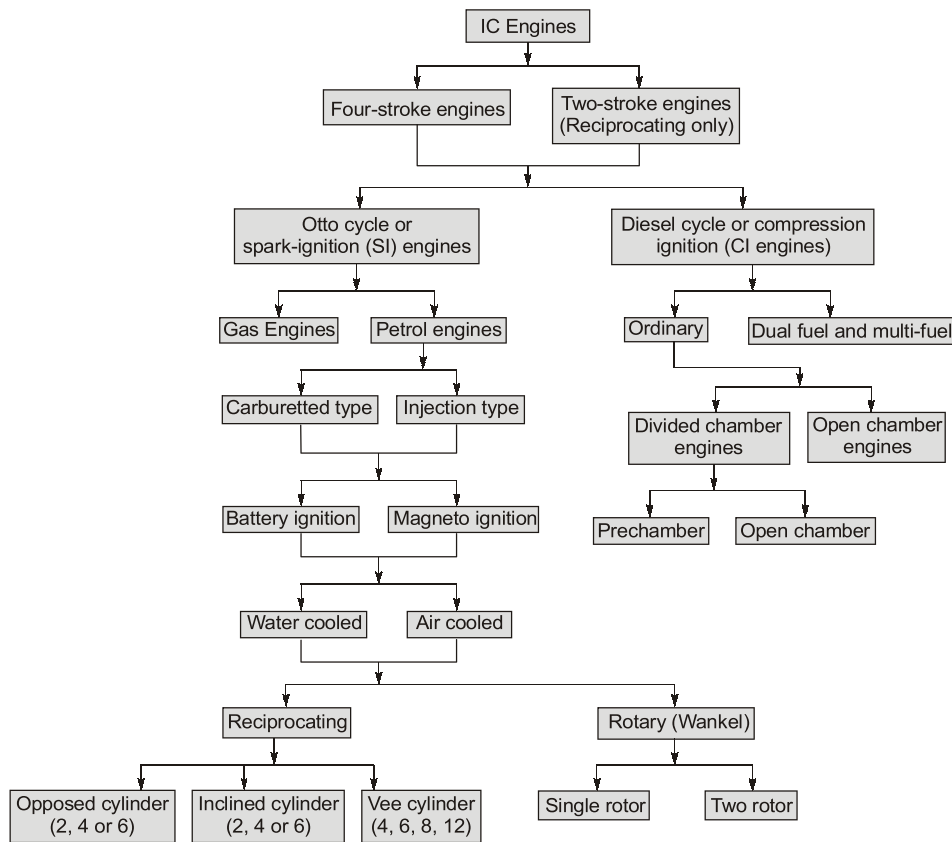

Fig. 1.2

The petrol engines use low compression ratio. The fuel and air mixture as a charge is ignited by a high intensity spark. Therefore, they are also called spark ignition (SI) engines. The diesel engines use high compression ratio, and the compressed charge is autoignited. Therefore, they are also called compression ignition (CI) engines.

### 1.3 Components of Engines

The essential part of Otto cycle engine and diesel cycle engine are same. It consists of large number of parts and since each part has its own function, material and manufacturing process is decided by power requirement.

- Cylinder :** It is the heart of the engine. The piston reciprocate in the cylinder. It has to withstand high pressure and temperature and thus it is made strong. It is provided with a cylinder liner on the inner side and a cooling arrangement on its outer side.

Generally cylinder is made by cast iron because cast iron has high compressive strength to handle high pressure and temperature. It is made by casting and generally cast in one piece. But since cast iron engines are heavy and increases the inertia of engine thus decreasing the mileage of vehicle. So, in modern vehicles cylinder is made up of steel alloy or Al-alloy which reduces the weight and hence better fuel economy can be get with slight sacrifice of strength.

- Piston :** It is the reciprocating member of the engine. It reciprocates in the cylinder. It is usually made up of cast iron or aluminium alloy. Its top surface is called piston crown and bottom surface is called piston skirt.

It is the prime mover in engine that is the reason it should be light also it should have high strength to handle high pressure and temperature of combustion gases. It is also made by casting mainly.

- Cylinder head :** The top cover of the cylinder, towards TDC is called cylinder head. It houses spark plug in petrol engines and fuel injector in diesel engines along with housing of inlet and exhaust valves in 4-stroke engine. Its main function is to seal the cylinder.

- It is made up of cast iron or aluminium alloy by casting or forging usually in single piece.

- Piston rings :** Two or three piston rings are provided on the piston. Minimum two rings are needed to prevent blow by losses of high pressure gases from cylinder to crank case.

- Its main function is to seal the space between cylinder liner and piston and it is also used to provide uniform lubricating and scrap out the lubricating in the return stroke.

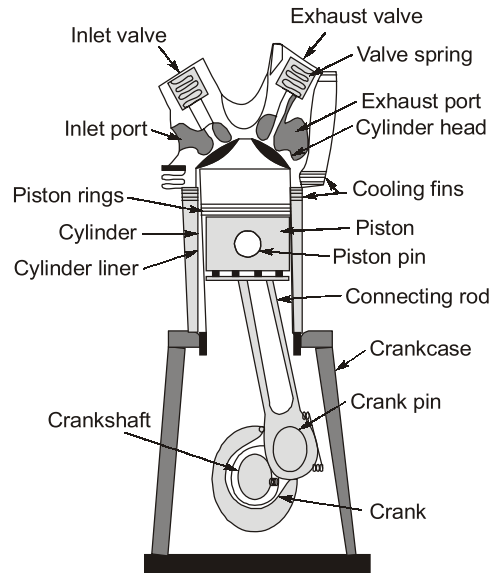

**Fig. 1.3 :** Details of an internal combustion engine

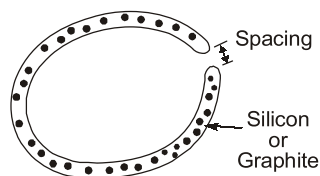

**Fig. 1.4**

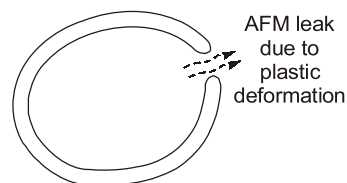

**Fig. 1.5**

- It should be smooth to reduce frictional losses during reciprocating motion of piston. Silicon or Graphite (act as solid lubrication) is used to make it smooth although it makes steel brittle.
- Piston ring should be brittle because if it is ductile then after some usage a gap will be created, from where air-fuel mixture (AFM) may leak out during compression thus increases blow by losses.

5. **Gudgeon pin or piston pin** : Gudgeon pin is used to connect piston with connecting rod. It is subjected to fatigue loading condition hence it is made up of “Forged steel (cold)” to prevent its high failure rate. Forging removes internal defect and machining will remove surface defect so life increases due to absence of crack.
6. **Crank** : It is a rotating member. It makes circular motion in the crank case (its housing). Its one end is connected with a shaft called crank-shaft and the other end is connected with a connecting rod.
7. **Crank Case** : It is the housing of the crank and body of the engine to which cylinder and other engine parts are fastened. It also acts as a ground for lubricating oil.
8. **Connecting Rod** : It is a link between the piston and crank. Its one end is connected with a crank and other end is connected with a piston. It transmits power developed on the piston to a crank shaft through crank. It is usually made of medium carbon steel.
9. **Crank Shaft** : It is the shaft, a rotating member, which connects the crank. The power developed by the engine is transmitted outside through this shaft. It is made of medium carbon or alloy steels.
10. **Cooling Fins or Cooling Water Jackets** : During combustion, the engine releases a large amount of heat. Thus the engine parts may be subjected to a temperature at which engine parts may not sustain their properties such as hardness, etc. In order to keep the engine parts within safe temperature limits, the cylinder and the cylinder head are provided with a cooling arrangement. The cooling fins are provided on light duty engines, while a cooling water jacket is provided on medium and heavy duty engines.
11. **Cam Shaft** : It is provided on four-stroke engines. It carries two cams, for controlling the opening and closing of inlet and exhaust valves.
12. **Inlet Valve** : This valve controls the admission of charge into the engine during a suction stroke.
13. **Exhaust Valve** : The removal of exhausted gases after doing work on the piston is controlled by the valve.
14. **Inlet manifold** : It is the passage which carries the charge from carburettor to the engine.
15. **Exhaust manifold** : It is the passage which carries the exhaust gases from the exhaust valve to the atmosphere.
16. (a) **Spark Plug** : It is provided in petrol engines. It produces a high-intensity spark which initiates the combustion process of the charge.  
 (b) **Fuel Injector** : It is provided in diesel engines. The diesel fuel is injected in the cylinder at the end of the compression through a fuel injector under very high pressure.
17. (a) **Carburettor** : It is provided with a petrol engine for preparation of a homogeneous mixture of air and fuel (petrol). This mixture, as a charge, is supplied to engine cylinder through suction valve or port.  
 (b) **Fuel Pump** : It is provided with a diesel engine. The diesel is taken from the fuel tank, its pressure is raised in the fuel pump and then it is delivered to fuel injector.
18. **Fly wheel** : It is mounted on the crankshaft and is made of cast iron. It stores energy in the form of inertia, when energy is in excess and it gives back energy when it is in deficit. In other words, it minimizes the speed fluctuations on the engine.

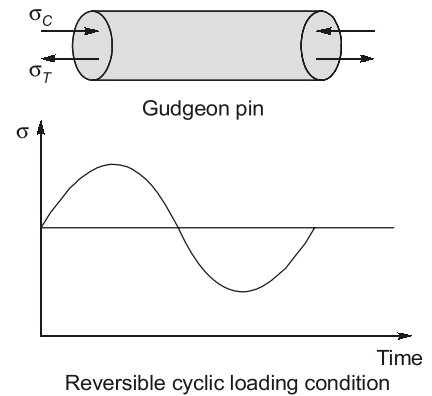
**Fig. 1.6**

## 1.4 Basic Terminology

The basic terminology used for volumes and measurements in the cylinder region is presented and shown in Fig. 1.7.



- Bore (d)** : It is the inside diameter of the engine cylinder. It is called the bore as it is made by boring process.
- Stroke (L)** : During the travel of the piston, there is an upper as well as a lower limiting position at which the direction of motion of the piston is reversed. The linear distance through which the piston travels between the extreme upper and lower positions of the piston is called the stroke. It is equal to two times the crank radius,  $L = 2r$ , where  $r$  is the crank radius.
- Top Dead Centre (TDC)** : When the piston is at the topmost position of the cylinder during its travel, that position is called the Top Dead Centre. At this position the piston velocity is zero and the piston reverses its direction of motion to travel downwards. It is the dead centre when the piston is farthest from the crankshaft.
- Bottom Dead Centre (BDC)** : When the piston is at the bottom-most position of the cylinder during its travel, that position is called the Bottom Dead Centre. At this position the piston velocity is zero and the piston reverses its direction of motion to travel upwards. It is the dead centre when the piston is nearest to the crankshaft.
- Clearance Volume ( $V_c$ )** : When the piston is at the TDC, the volume contained in the cylinder above the top of the piston is called the clearance volume. The piston cannot occupy any part of this volume and always keeps this volume clear.
- Piston Displacement or Swept Volume ( $V_s$ )** : It is the volume swept by the piston while moving between the TDC and the BDC, i.e.

$$V_s = \frac{\pi}{4} d^2 L \quad \dots (i)$$

- Cylinder Volume (V)** : The cylinder volume includes both the clearance volume and the swept volume, i.e.

$$V = V_c + V_s \quad \dots (ii)$$

- Compression Ratio (r)** : It is the ratio of the volume when the piston is at BDC to the volume when the piston is at TDC. Hence, it is the ratio of total cylinder volume to clearance volume.

$$r = \frac{V}{V_c} = \frac{V_c + V_s}{V_c} = 1 + \frac{V_s}{V_c} \quad \dots (iii)$$

- Mean Piston Speed** : As the piston moves inside the engine cylinder its speed changes continuously. It is zero at TDC and BDC, maximum nearly at the mid-position of TDC and BDC. The crank angle  $\theta$  is zero at TDC, it is almost  $90^\circ$  when the piston speed is maximum and  $180^\circ$  at BDC. In the limit of infinitely long connecting rod, the motion is simple harmonic and maximum speed will be at  $90^\circ$  crank angle. Thus in a half rotation of the crank, the piston moves a distance equal to the length of the stroke,  $L$ . In full rotation, the distance travelled by piston will be  $2L$ . If  $N$  is the engine speed in revolutions per minute (rpm) and  $L$  is in metres, the mean piston speed will be  $2LN/60$  m/s.

$$\text{Mean or Average piston speed, } \bar{u}_p = \frac{2LN}{60} \text{ m/s} \quad \dots (iv)$$

Maximum value of mean piston speed is kept within the range of 8 – 15 m/s. This keeps the resistance to the gas flow into the engine intake system and stresses due to the inertia of the moving parts within safe limit. Automobile engines operate at the higher end and large marine diesel engines operate at lower end of this range.

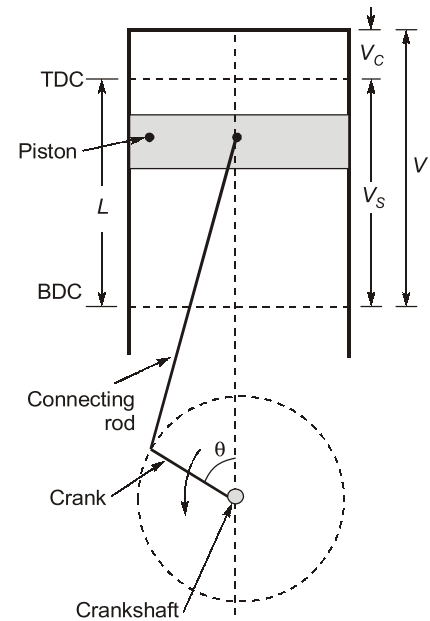

**Fig. 1.7:** Basic Terminology for engines

## 1.5 Otto Cycle Engines : Petrol Engines

The ordinary Otto-cycle engine is a four-stroke engine; that is, its piston makes four strokes, two toward the cylinder head (TDC) and two away from the head (BDC). By suitable design, it is possible to operate an Otto-cycle as a two-stroke cycle engine with one power stroke in every revolution of the engine. Thus, the power of a two-stroke cycle engine is theoretically double that of a four-stroke cycle engine of comparable size. These engines are also called spark ignition engines.

### 1.5.1 Four-Stroke Cycle Petrol Engine

All operations are carried out in four strokes of the piston, i.e. two revolutions of the crank shaft. Therefore, the engine is called a four-stroke engine.

- (a) **Constructional Details** : Similar to a two-stroke engine, it also consists of a cylinder, cylinder head attached with spark plug, piston attached with piston rings, connecting rod, crank, crank shaft, etc. as shown in figure . In a four-stroke engine, valves are used instead of ports. There are suction and exhaust valves. These valves are operated by cams attached on a separate shaft, called a cam shaft. It is rotated at half the speed of a crank shaft.
- (b) **Operation** : The travel of the piston from one dead centre to another is called piston stroke and a four stroke cycle consists of four strokes as suction, compression, expansion and exhaust strokes.
  - (i) **Suction Stroke** : The suction valve opens, exhaust valve remains closed as shown in Fig 1.8. The piston moves from the top dead centre to the bottom dead centre, the charge (mixture of fuel and air prepared in the carburettor) is drawn into the cylinder.
  - (ii) **Compression Stroke** : When the piston moves from the bottom dead centre to top dead centre, and the suction valve is closed, exhaust valve remains closed as shown in figure. The trapped charge in the cylinder is compressed by the upward moving piston. As the piston approaches to the top dead centre, the compression stroke completes.
  - (iii) **Expansion Stroke** : At the end of the compression stroke, the compressed charge is ignited by a high-intensity spark created by a spark plug, combustion starts and the high-pressure burning gases force the piston downward as shown in figure. The gas pressure performs work, therefore, it is also called working stroke or power stroke. When the piston approaches to the bottom dead centre in its downward stroke, then this stroke is completed. In this stroke, both valves are closed.
  - (iv) **Exhaust Stroke** : When the piston moves from the bottom dead centre to the top dead centre, only the exhaust valve opens and burnt gases are expelled to surroundings by upward movement of the piston as shown in figure. This stroke is completed when the piston approaches the top dead centre. Thus, one cycle of a four-stroke petrol engine is completed. The next cycle begins with piston movement from the top dead centre to the bottom dead centre.

In Fig. 1.9 show the p-V diagram with a schematic diagram of a four-stroke petrol engine.

- (c) **Valve Timing** : Theoretically, in a four-stroke cycle engine, the inlet and exhaust valves open and close at dead centres as shown in Fig. 1.10.

A typical valve-timing diagram for a four-stroke petrol engine is shown in Fig 1.10. The angular positions in terms of crank angle with respect to TDC and BDC position of piston are quoted on the diagram.

When the inlet valve and exhaust valve remain open simultaneously, it is called a valve overlap.

- (d) **Applications** : These engines are mostly used in automobiles, motor cycles, cars, buses, trucks, aeroplanes, small pumping sets, mobile electric generators, etc. Nowadays, the four-stroke petrol engines have been replaced by four-stroke diesel engines for most applications.

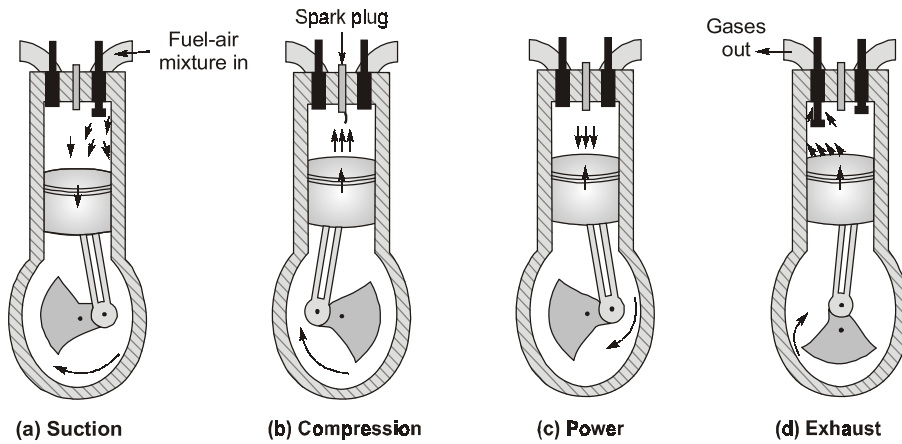
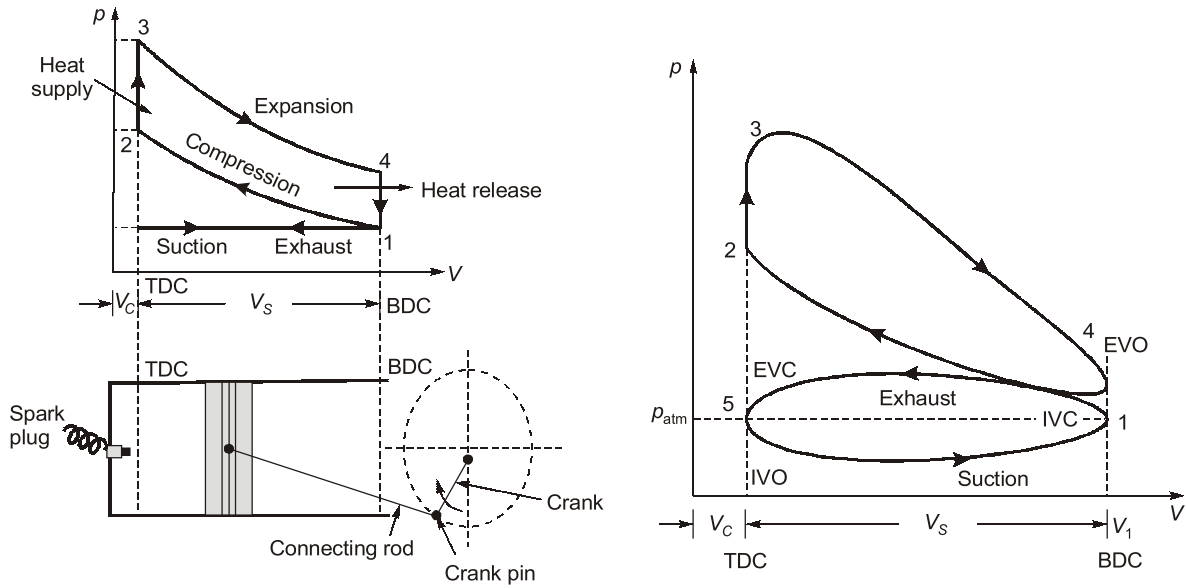

Fig. 1.8



(a) Theoretical p-V diagram for a four-stroke petrol engine

(b) Actual p-V diagram for four-stroke petrol engine

Fig. 1.9

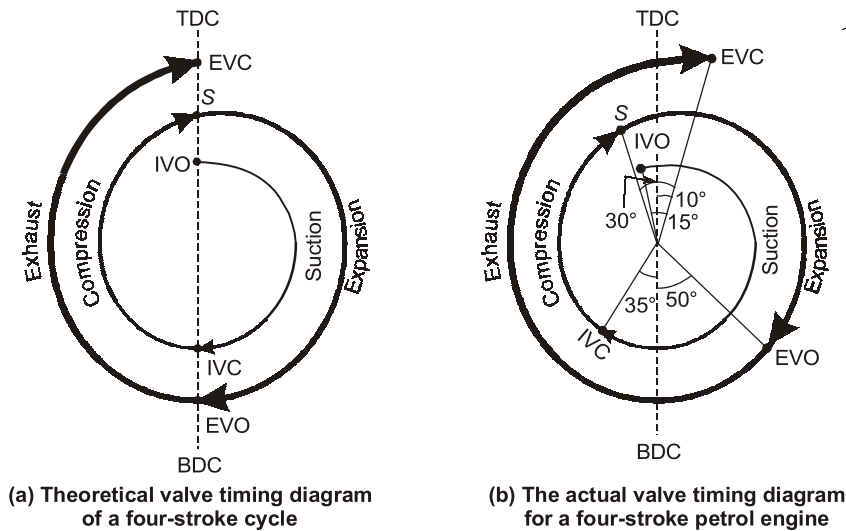

Fig. 1.10

IVO = Inlet valve opens when piston at TDC  
 IVC = Inlet valve closes, when piston reaches BDC  
 S = Spark produces, when piston reaches TDC  
 EVO = Exhaust valve opens when piston at BDC  
 EVC = Exhaust valve closes, when piston at TDC

IVO = Inlet valve opens about  $15^\circ$  before TDC  
 IVC = Inlet valve closes  $20^\circ$ - $40^\circ$  after BDC to take advantage of rapidly moving gas  
 S = Spark occurs  $20^\circ$ - $40^\circ$  before TDC  
 EVO = Exhaust valve opens about  $50^\circ$  before BDC  
 EVC = Exhaust valve close about  $0^\circ$  to  $10^\circ$  after TDC

## 1.5.2 Spark Plug

It is used to ignite the compressed air fuel mixture in combustion chamber by creating an electric spark by ionizing air in spark gap by maintaining high potential difference.

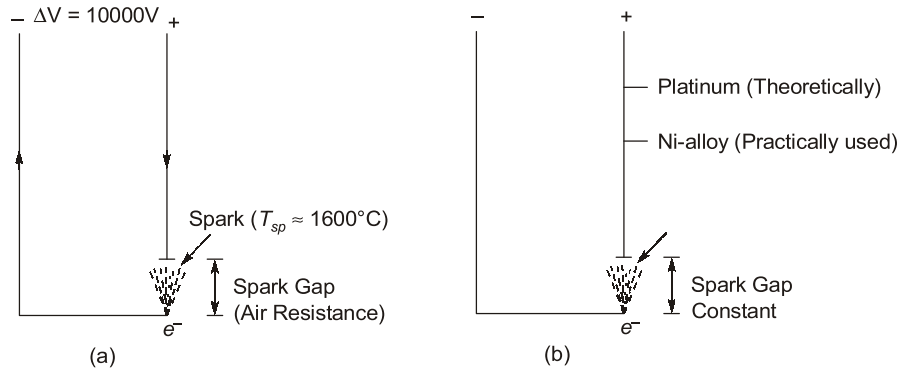

Fig. 1.11

- Theoretically platinum should be used because of high “electron discharge capacity” but it is not used practically due to high co-efficient of thermal expansion and due to which spark gap will change with temperature.
- Practically Ni-alloy (super alloy) are “thermally insensitive” so spark gap is constant and spark strength will be max at particular spark gap.

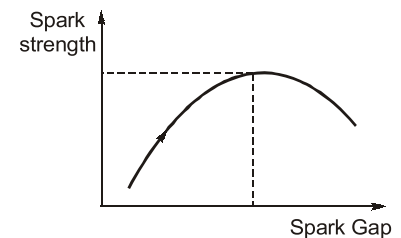

Fig. 1.12

## 1.6 Diesel Engines

### 1.6.1 Four-Stroke Diesel Engine

A four-stroke diesel engine contains a fuel injector, fuel pump, cylinder, cylinder head, inlet and exhaust valves, piston attached with piston rings, connecting rod, crankshaft, cams, camshaft, etc. as shown in Fig. 1.13. One cycle of a four-stroke diesel engine is completed in four-strokes of the piston or two revolutions of the crank shaft.

**(a) Working of Engine :** The four-stroke diesel engine operates in a similar manner as a four-stroke petrol engine. A schematic diagram of a four-stroke diesel engine is shown in Fig. 1.14. The details of operations are discussed below:

- (i) Suction Stroke :** The inlet (suction) valve opens, the exhaust valve remains closed, only air is drawn into the cylinder as the piston moves from the top dead centre to the bottom dead centre. This stroke ends as the piston approaches the bottom dead centre.

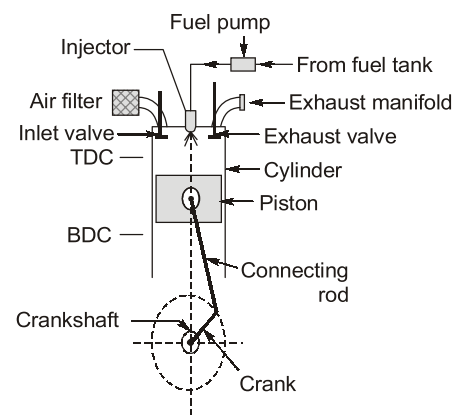

Fig. 1.13: Four-Stroke Diesel Engine

(ii) **Compression Stroke** : As the piston moves from the bottom dead centre to the top dead centre, the inlet valve closes, exhaust valve remains closed as shown in Fig. 1.14. The air trapped into the cylinder is compressed in the cylinder till the piston approaches the top dead centre. The air temperature reaches about  $800^{\circ}\text{C}$  by compression.

At the end of the compression stroke, the fuel is injected at very high pressure into the compressed hot air. The temperature of hot compressed air is sufficient to ignite the injected fuel. Thus, ignition takes place inside the cylinder.

(iii) **Expansion Stroke** : During this stroke, both valves remain closed as shown in Fig. 1.14. The piston at the top dead centre is pushed by expansion of burning gases. Actual work is obtained during this stroke due to the force obtained by high pressure burning gases. Therefore, this stroke is called power stroke or working stroke.

(iv) **Exhaust Stroke** : During this stroke, the piston moves from the bottom dead centre to the top dead centre, exhaust valve opens and the inlet valve remains closed. Burnt gases of the previous stroke are expelled out from the cylinder by upward movement of the piston.

The theoretical p-V diagram is shown in Fig. 1.15 for a four-stroke Diesel engine operation.

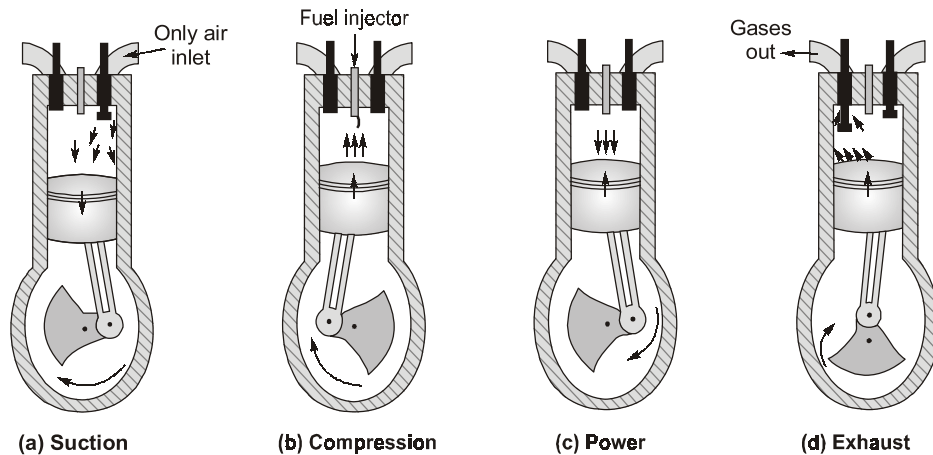

**Fig. 1.14**

(b) **Valve-Timing Diagram:** Theoretically, the inlet and exhaust valves open at dead centres as shown in Fig. 1.16. A typical valve-timing diagram for a four-stroke diesel engine is shown in Fig. 1.16.

(c) **Applications:** The four-stroke diesel engine is one of the most popular prime movers. It is manufactured from 50 mm to 1000 mm cylinder bore with speeds ranging from 100 rpm to 4500 rpm. It has wide applications. Some of these are

- (i) Small pumping sets for agriculture,
- (ii) Construction machinery,
- (iii) Air compressor and drilling jigs,
- (iv) Tractors, jeeps, cars, taxis, buses, trucks,
- (v) Diesel-electric locomotives,
- (vi) Small power plants, mobile electric generating plants,
- (vii) Boats and ships,
- (viii) Power saws, Bulldozers, tanks, etc.

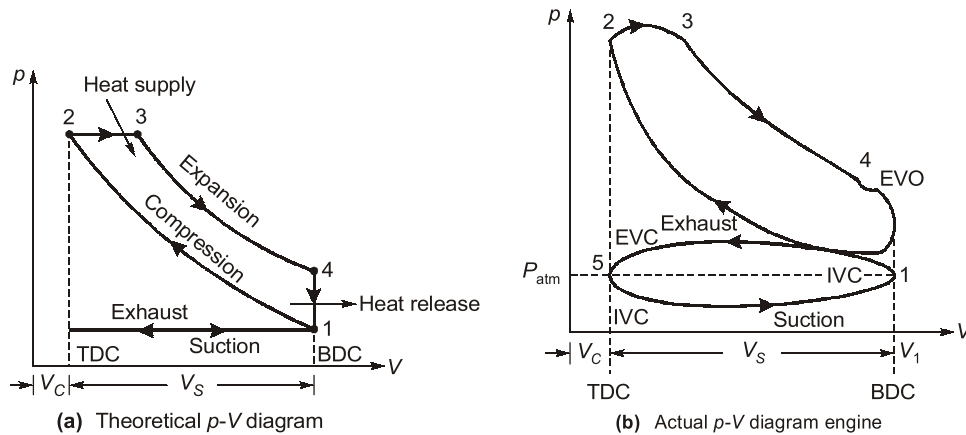

Fig. 1.15

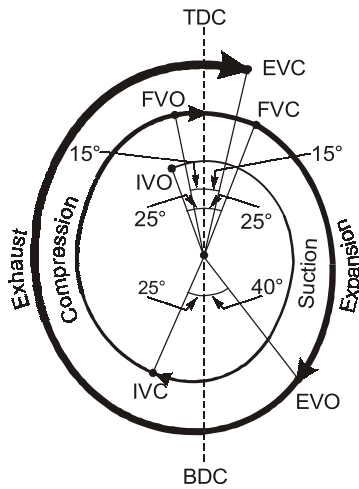

Fig. 1.16 : Valve Timing Diagram for a Four-Stroke Diesel Engine

### 1.6.2 Mean Effective Pressure

To understand mean effective pressure let us take an imaginary area of  $10 \text{ cm}^2$ . The maximum length of Area is taken as " $L_d$ " and with some  $L_d$  height is chosen  $h_m$  such that the drawn rectangle will have some area of  $10 \text{ cm}^2$ .

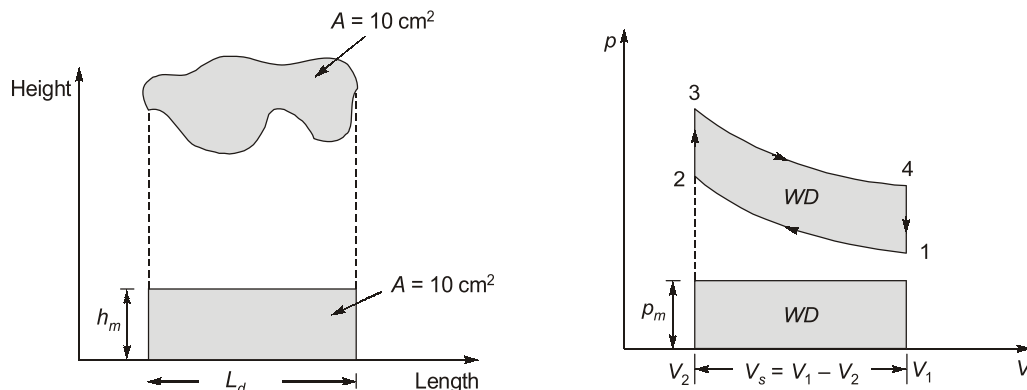

Fig. 1.17

It is an imaginary pressure which will give us the same work done as by actual cycle for the same change in volume.

i.e., 
$$W_{\text{net}} = p_m \times V_s$$

Since, 
$$(WD)_{\text{net}} = \int_2^1 p_m dV = p_m(V_1 - V_2)$$

$$\therefore (WD)_{\text{net}} = p_m V_s$$

## 1.7 Constant Volume or Otto cycle

This cycle is so named as it was conceived by 'Otto'. On this cycle, Petrol, gas and many types of oil engines work. It is the standard or comparison for internal combustion engines.

Figure 1.18 (a) and (b) shows the theoretical p-V diagram and T-s diagrams of this cycle respectively.

- The point 1 represents that cylinder is full of air with volume  $V_1$ , pressure  $p_1$  and absolute temperature  $T_1$ .
- Process 1 - 2 represents the adiabatic compression of air due to which  $p_1$ ,  $V_1$  and  $T_1$  change to  $p_2$ ,  $V_2$  and  $T_2$  respectively.
- Process 2 - 3 shows the supply of heat to the air at constant volume so that  $p_2$  and  $T_2$  change to  $p_3$  and  $T_3$  ( $V_3$  being the same as  $V_2$ ).
- Process 3 - 4 represents the adiabatic expansion of the air. During expansion  $p_3$ ,  $V_3$  and  $T_3$  change to a final value of  $p_4$ ,  $V_4$  or  $V_1$  and  $T_4$  respectively.

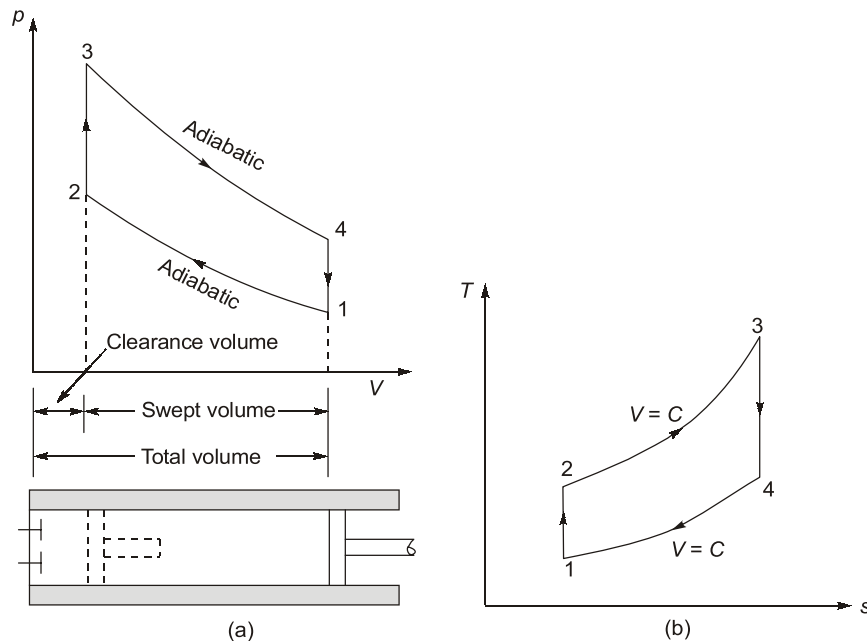

**Fig. 1.18**

- Process 4 - 1 shows the rejection of heat by air at constant volume till original state 1 reaches.

Consider 1 kg of air (as working substance) :

$$\text{Heat supplied at constant volume} = c_v(T_3 - T_2)$$

$$\text{Heat rejected at constant volume} = c_v(T_4 - T_1)$$

But, Work done = Heat supplied - Heat rejected

$$= c_v(T_3 - T_2) - c_v(T_4 - T_1)$$



Refer to T-s diagram in previous Fig. 1.36 (b). For same work output the area 1-2-3-4 (work output of Otto cycle) and area 1-2'-3'-4' (work output of Diesel cycle) are same. To achieve this, the entropy at 3 should be greater than entropy at 3'. It is clear that the heat rejection for Otto cycle is more than that of Diesel cycle. Hence, for these conditions, the Diesel cycle is more efficient than the Otto cycle. The efficiency of Dual cycle lies between the two cycles.

- So for all the cases except when same compression ratio,

$$\eta_{\text{Diesel}} > \eta_{\text{Dual}} > \eta_{\text{Otto}}$$

$$\eta_{\text{Joule}} < \eta_{\text{Otto}}$$

- In actual cycle, the assumption for air-standard cycle do not hold true for all the points. So efficiency of actual cycle is lower than air standard efficiency.

**The loss in efficiency of air standard cycle is due to the following reasons:**

- **Loss due to variation of specific heat with temperature:** As the temperature increases, specific heats ( $c_p, c_v$ ) both increases but  $\left(\gamma = \frac{c_p}{c_v}\right)$  decreases so efficiency decreases.
- **Loss due to dissociation:** At high temperature, the combustion products dissociate by absorbing some energy thereby reducing the efficiency.
- **Time loss:** Fuel does not combust instantaneously and completely but takes some time to burn so the maximum pressure is reduced and efficiency decreases so spark is advanced to reduce time loss.
- **Exhaust blow down loss:** Exhaust valve is opened during expansion stroke to reduce work done by piston for exhaust stroke.
- **Pumping loss:** The difference of work done in expelling the exhaust gases and the work done by fresh charge during suction is known as pumping loss.
- Losses occur due to friction in moving parts of the engine.

### Example 1.1

A four-cylinder, 4 stroke, spark ignition engine has bore of 100 mm and stroke of 120 mm. It runs at 1600 rpm. Fuel consumption per minute is 0.2 kg. The calorific value of fuel is 44 MJ/kg. Difference in tension on either side of brake pulley is 40 kg and brake circumference is 300 cm. The area of the indicated diagram is given as (i) +ve area is 5 cm<sup>2</sup> (ii) -ve area is 0.4 cm<sup>2</sup>. The length of indicated diagram is 6.5 cm. Indicated spring rating is 1 bar/mm.

Find

(i)  $\eta_{bth}$

(ii)  $\eta_{i th}$

(iii)  $\eta_m$

(iv)  $bsfc$

(v)  $p_{imep}$

**Solution:**

**Given :** Four-cylinder and four-stroke

$$D = 100 \text{ mm,}$$

$$L = 120 \text{ mm}$$

$$N = 1600 \text{ rpm}$$

$$\dot{m}_f = 0.2 \text{ kg/min}$$

$$CV = 44 \text{ MJ/kg}$$

$$W - S = 40 \text{ kg}$$

$$2\pi r_b = 300 \text{ cm}$$

$$r_b = 0.4775 \text{ m}$$

∴

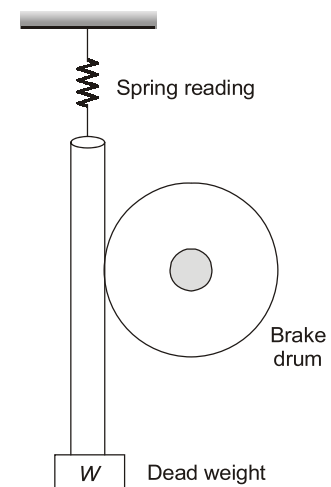



$$\text{Brake torque} = (W - S)r_b = 40 \times 9.81 \times 0.4775 = 187.357 \text{ Nm}$$

$$\therefore \text{Brake power, BP} = \frac{2\pi NT}{60} = \frac{2\pi \times 1600 \times 187.357}{60} = 31392 \text{ W}$$

To find indicated power,

$$\text{Net area} = 5 - 0.4 = 4.6 \text{ cm}^2$$

$$h_m = \frac{4.6 \text{ cm}^2}{6.5 \text{ cm}} = 0.7077 \text{ cm}$$

$$\therefore p_{\text{imep}} = 0.7077 \times 10 \times 1 = 7.077 \text{ bar}$$

$$\begin{aligned} \text{Swept volume, } \dot{V}_s &= \frac{\pi D^2 L}{4} \frac{NK}{120} \\ &= \frac{\pi}{4} \times 0.1^2 \times 0.12 \times \frac{1600 \times 4}{120} = 0.0503 \text{ m}^3/\text{s} \end{aligned}$$

$$\therefore \text{Indicated power, IP} = p_{\text{imep}} \times \dot{V}_s = 707.7 \times 0.0503 = 35.573 \text{ kW}$$

$$\text{Heat addition, HA} = \dot{m}_f \times CV = \frac{0.2}{60} \times 44000 = 146.667 \text{ kW}$$

$$(i) \quad \eta_{b \text{ th}} = \frac{BP}{HA} = \frac{31.392}{146.667} = 0.21404 = 21.404\%$$

$$(ii) \quad \eta_{i \text{ th}} = \frac{IP}{HA} = \frac{35.573}{146.667} = 0.24254 = 24.254\%$$

$$(iii) \quad \eta_m = \frac{BP}{IP} = \frac{31.392}{35.573} = 0.88247 = 88.247\%$$

$$(iv) \quad bsfc = \frac{\dot{m}_f}{BP} \times 3600 = 0.382 \text{ kg/kWh}$$

$$(v) \quad p_{\text{imep}} = 7.077 \text{ bar}$$

**Example 1.2**

The spark plug is fixed at  $18^\circ$  before top dead centre (TDC) in an SI engine running at 1800 rpm. It takes  $6^\circ$  of rotation to start combustion and get into flame propagation mode. Flame termination occurs at  $10^\circ$  after TDC. Flame front can be approximated as a sphere moving out from the spark plug which is offset 8 mm from the spark plug which is offset 8 mm from the centre line of the cylinder whose bore diameter is 8.4 cm. Calculate the effective flame front speed during flame propagation. The engine speed is increased to 2700 rpm and subsequently as a result of which the effective flame front speed increases at a rate such that it is directly proportional to 0.85 times of engine speed. Flame development after spark plug firing still takes  $6^\circ$  of engine rotation. Calculate how much engine rotation must be advanced such that the flame termination again occurs at  $10^\circ$  after TDC.

**Solution :**

**Given :** Flame initiation  $\theta_i = 6^\circ$ , Flame propagation at 1800 rpm,  $\theta_p = 28 - 6 = 22^\circ$

$$\text{Radius of cylinder} = \frac{84}{2} = 42 \text{ mm}$$

$$\text{Maximum distance to be covered} = 42 + 8 = 50 \text{ mm}$$

Time needed for  $22^\circ$  rotation at 1800 rpm,

$$t_1 = \frac{22}{360} \times \frac{60}{1800} \text{ sec} = 2.037 \times 10^{-3} \text{ sec}$$